

Dylan

Specifications

Year

2023

Designer

Rodolfo Dordoni

Dimensions

Various dimensions. 410mm seat height, backrest 640 H, 820 H with cushions.

Options

Fabric or leather in range of colours. Bases in Bronze or Pewter colour polished aluminium. Table tops in Moka or Tobacco lacquered ash.





Struttura: sedile in legno multistrato con rinforzi in metallo. Preparazione della struttura in poliuretano espanso a quote differenziate ad alta densità e cinghie elastiche, ad alta componente di caucciù, per garantire un maggiore comfort alla seduta.

Braccioli e schienali realizzati in legno multistrato, rivestiti con poliuretano espanso a quote differenziate, successivamente rivestiti con trapuntino di poliestere termolegata traspirante accoppiata con tela di cotone bianca.

Tutti i materiali impiegati per la realizzazione del trapuntino sono anallergici e prodotti con materiali riciclati.

La confezione della fodera della struttura schienale/bracciolo e dei cuscini sedile e schienale è contraddistinta da un profilo e da morbide impunture d'ispirazione couture che conferiscono un'immediata sensazione di comfort grazie alla leggera curva dello schienale e del bracciolo.

Per aumentare la sofficietà, la fodera dello schienale/bracciolo prevede una trapuntatura che accoppia la fibra termolegata di forte spessore con la tela di cotone bianca, alla fodera. Il rivestimento della base strutturale è realizzato tramite fasce di tessuto o pelle, lavorate con la stessa tecnica usata per il sistema di sedute Connery, cucite tra loro tramite fettucce e caratterizzate da accurate cuciture rifinite a mano.

Piani d'appoggio: il sistema di sedute prevede la possibilità di avere per alcuni elementi un top in stratificato di MDF e alluminio, spessore mm 18, impiallacciato in frassino laccato a poro aperto color Moka o tinto a poro aperto color Tabacco, disponibile in diverse dimensioni e configurazioni.

Cuscinatura: imbottitura cuscini sedile e schienale in piuma d'oca canalizzata ad alto spessore, per conferire grande sofficietà ed aumentare il comfort, sottoposta a regolare trattamento di bonifica igienico-sanitaria come stabilito dal Regolamento CE 1069/2009 (certificata Assopiuma, Etichetta Oro). Successivamente rivestiti da fibra termolegata traspirante accoppiata con tela di cotone bianca anallergica. Cuscini sedile con inserto in poliuretano espanso a quote differenziate ad alta resilienza, rivestito nella parte superiore con materiale poliuretano termosensibile. Cuscini schienale con inserto centrale in poliuretano espanso a quote differenziate ad alta resilienza in materiale anch'esso termosensibile e sagomato per adattarsi perfettamente alla raffinata e funzionale conformazione dello schienale imbottito.

Structure: seat in metal-reinforced plywood. The seat structure is padded with high-resilience, variable-density polyurethane foam with high-rubber-content elastic webbing to maximize comfort. The plywood armrest and backrest structures are covered in high-resilience, variable-density polyurethane foam, then encased in breathable heat-bonded polyester quilted fibre laminated to white cotton fabric.

All of the materials employed in manufacturing the quilting are hypoallergenic and made with recycled materials. Tailoring of the backrest/armrest structure upholstery and of the seat and backrest cushions is distinguished by piping and couture-inspired soft top-stitching that convey an immediate sense of comfort, thanks to the slight curve of the backrest and armrest.

To increase fluffiness, the backrest and armrest upholstery has quilting that joins the thick heat-bonded fibre encased in white cotton fabric to the upholstery.

The structural base is sheathed in strips of fabric or leather, tailored using the same techniques used in the Connery seating system, stitched together using laces embellished with fine hand-finished stitching.

Table-top surfaces: the seating system includes the option of a top laminated MDF and aluminium, for some elements, 18 mm thick, in ash veneer with open pore Moka colour lacquer finish or open-pore Tobacco colour stain, available in various sizes and configurations.

Cushions: seat and backrest cushions, padded in high-loft channelled goose down to lend greater softness and increase comfort, undergo routine sanitization as specified in EC Regulation No. 1069/2009 (Assopiuma certified, Gold Label). They are then encased in breathable heat-bonded fibre laminated to white hypoallergenic cotton fabric. Seat cushions with high resilience, variable-density polyurethane foam insert are covered in the upper part with temperature-sensitive polyurethane material. Backrest cushions with core insert in high-resilience, variable-density polyurethane foam in material that is also temperature-sensitive and contoured to adapt perfectly to the sophisticated, functional shape of the upholstered backrest.

Struktur: Sitzfläche aus Sperrholz mit Metallverstärkungen. Polsterung der Struktur aus PU-Schaum mit differenzierter, hoher Dichte und mit Federung durch elastische Riemen mit hohem Kautschukanteil für angenehm weichen Sitzkomfort. Armlehnen und Rückenlehnen aus Sperrholz mit Polsterung aus PU-Schaum mit unterschiedlicher Dichteverteilung und einer weiteren gesteppten Polsterung aus atmungsaktiver, thermofixierter Faser mit Bezug aus weißer Baumwolle. Alle, für die gesteppte Polsterung verwendeten Materialien sind antiallergisch und bestehen aus recycelten Materialien.

Die Konfektionierung des Bezugs der Struktur von Rücken- und Armlehne und der Sitz- und Rückenissen zeichnet sich durch ein Profil und weiche Steppnähte aus, die sich an der Haute Couture inspirieren und mit der leicht geschwungenen Rücken- und Armlehne ein unmittelbares Gefühl von Komfort vermitteln. Um den Sitzkomfort zu erhöhen, ist der Polsterung der Rücken- und der Armlehne mit einer Steppung ausgeführt, die die thermofixierte, sehr dicke Faser mit Bezug aus weißer Baumwolle mit der Polsterung verbindet.

Der Bezug der Basis ist in Stoff- oder Lederstreifen ausgeführt, die mit der gleichen Technik verarbeitet werden, die auch für das Sofasystem Connery verwendet wird und durch sorgfältige, von Hand ausgeführte Nähte charakterisiert ist.

Ablageflächen: Das Sofasystem sieht für einige Elemente eine Ablagefläche aus MDF-Schichtholz und Aluminium, Stärke 18 mm vor, in der Ausführung Eschenholzurnier offenporig lackiert in der Farbe Mokka oder gebeizt in der Farbe Tabak, die in verschiedenen Abmessungen und Konfigurationen erhältlich ist.

Kissen: Rückenissen und Sitzkissen mit gesteppter Daunenfüllung mit Kammern und Innenstegen mit hoher Stärke für weiche Kissen und mehr Sitzkomfort, die nach Vorgabe der Verordnung (EU) 1069/2009 (zertifiziert Assopiuma, "Goldenes Etikett") ordnungsgemäß sterilisiert worden ist. Zusätzliche Polsterung aus atmungsaktiver, thermofixierter Faser mit Bezug aus weißer, antiallergischer Baumwolle. Sitzkissen mit zentralem Einsatz aus hochwiderstandsfähigem PU-Schaum mit differenzierter Dichte mit Polsterung auf der Oberseite mit thermosensitivem Memory-Schaum. Rückenissen mit zentralem Einsatz aus hochwiderstandsfähigem PU-Schaum mit differenzierter Dichte, der ebenfalls thermosensitiv und geformt ist, um sich perfekt an die elegante und funktionelle Form der gepolsterten Rückenlehne anzupassen.

Structure : assise en multiplis avec renforts métalliques. Préparation de la structure en mousse polyuréthane à densité différenciée haute densité et sangles élastiques à haute teneur en caoutchouc, afin de garantir un plus grand confort d'assise.

Accoudoirs et dossiers en multiplis, recouverts de mousse polyuréthane à densité différenciée, puis recouverts d'un tissu multicouche matelassé en fibre de polyester thermoliée respirante et toile de coton blanche. Tous les matériaux utilisés pour la réalisation du tissu multicouche matelassé sont hypoallergéniques et fabriqués à partir de matériaux recyclés.

La confection du revêtement de la structure dossier/accoudoir et des coussins de l'assise et du dossier est caractérisée par un cordon et par des surpiques souples d'inspiration couture qui procurent une sensation immédiate de confort due également à la légère courbure du dossier et de l'accoudoir.

Pour augmenter le moelleux, le revêtement du dossier/accoudoir est doublé d'un tissu multicouche matelassé en fibre thermoliée de forte épaisseur et toile de coton blanche.

Le revêtement du piètement est réalisé avec la technique utilisée pour le système de sièges Connery, à l'aide de bandes de tissu ou de cuir cousues entre elles moyennant des rubans et caractérisées par des coutures soignées et finies à la main.

Tablettes : le système de sièges offre la possibilité de disposer, pour certains éléments, d'une tablette en MDF stratifié et aluminium, de 18 mm d'épaisseur, plaquée frêne laqué à pores ouverts couleur Moka ou teinté à pores ouverts couleur Tabac, disponible en différentes tailles et configurations.

Coussins : rembourrage des coussins d'assise et de dossier en plume d'oie cloisonnée de forte épaisseur pour apporter beaucoup de moelleux et augmenter le confort, soumise à un traitement d'assainissement conformément au règlement CE 1069/2009 (Certifiée Assopiuma, Label Or). Par la suite, ils sont recouverts d'un tissu multicouche en fibre thermoliée respirante et toile de coton blanche hypoallergénique. Coussins d'assise avec insert en mousse polyuréthane à densité différenciée haute résilience, recouvert sur le dessus de matériau polyuréthane thermosensible. Coussins de dossier avec insert central en mousse polyuréthane à densité différenciée haute résilience, également thermosensible et façonné pour épouser parfaitement les formes raffinées et fonctionnelles du dossier rembourré.

Minotti

Sfoderabilità: struttura, cuscini sedile e schienale completamente sfoderabili in tutte le versioni (tessuto o pelle).

Basi: portanti, in estruso di alluminio verniciato lucido anti-touch color Bronzo o Peltro.

Scivolante protettivo in polietilene di colore bronzo o nero, in abbinamento alla finitura scelta per la base.

Per permettere la sfoderabilità, gli elementi schienale/bracciolo e i piani d'appoggio (ove presenti) sono facilmente sfilabili dalle loro sedi agendo sulle apposite manopole poste sotto la struttura portante. Questa operazione, in casi necessari, può essere eseguita anche per agevolare il trasporto e la consegna.

AVVERTENZE SULLA CONFEZIONE DELLA FODERA

A) Rivestimento tutto in tessuto o in pelle;

B) Rivestimento della base in pelle cat. Nature, cuscini sedile e schienale in tessuto.

Non è possibile realizzare la base di questo prodotto nei tessuti: Velvet, Gary, Hunt, Kabuki, Kerlin, Leopold, Tibet Square, Timothy.

POGGIATESTA

Realizzato in multistrato rivestito in poliuretano espanso ad alta densità, successivamente rivestito con fibra termolegata traspirante accoppiata con tela di cotone bianca. Per migliorare l'aderenza dell'elemento alla seduta, all'interno della fascia, in corrispondenza del cuscino sedile, è stato inserito un contrappeso. La fodera può essere realizzata a scelta nei tessuti o pelli a campionario, qualora non venisse specificata all'atto dell'ordine verrà coordinata al rivestimento del divano. Tessuto antiscivolo sul fondo. Completamente sfoderabile.

Covers: upholstery for the structure, seat and backrest cushions is completely removable in all versions (fabric and leather).

Bases: weight-bearing, in extruded aluminium with varnished polished Bronze or Pewter colour finish.

Bronze or black colour protective polyethylene glides to match the base finish.

For removal of upholstery, the backrest/armrest elements and table-tops (where included) can easily be lifted out by releasing the levers located underneath the support structure. If needed, this operation can also be used to facilitate shipping and delivery.

INFORMATION REGARDING UPHOLSTERY AND COVERS

A) All-fabric or all-leather upholstery;

B) base upholstered in cat. Nature Leather, seat and backrest cushions in fabric.

It is not possible to make the base of this product using the following fabrics: Velvet, Gary, Hunt, Kabuki, Kerlin, Leopold, Tibet Square, Timothy.

HEADREST

Made of plywood coated in high-resilience polyurethane foam, then sheathed in breathable, heat-bonded fiber laminated to white cotton canvas.

To improve adherence of the element to the seat, a counterweight is inserted inside the fabric strip where it meets the seat cushion. Headrest upholstery can be chosen from among the fabric or leather in the sample books; if not specified at the time the order is placed, it will be matched to the sofa upholstery.

Non-slip fabric on the bottom. Cover completely removable.

Abziehbarkeit: Struktur, Sitzkissen und Rückenlehnen sind in allen Versionen (Stoff oder Leder) komplett abziehbar.

Basis: Tragende Kufen aus extrudiertem Aluminium mit glänzender Anti-Touch-Lackierung in der Farbe Bronze oder Zinn. Schutzgleiter aus Polyethylen in der Farbe Bronze oder Schwarz in der gleichen Ausführung wie die Kufen.

Für das Abziehen der Bezüge können die Rückenlehnen und Armlehnen und die Ablageflächen (falls vorhanden) mit Hilfe der speziellen Drehknöpfe unter der tragenden Basis leicht aus ihren Sitzen gezogen werden. Bei Bedarf kann diese Möglichkeit auch genutzt werden, um den Transport und die Lieferung des Sofas zu erleichtern.

HINWEISE ZUR KONFEKTIONIERUNG DES BEZUGS

A) Bezug komplett aus Stoff oder Leder.

B) Bezug der Basis aus Leder der Kat. Leder Nature, Sitzkissen und Rückenlehne mit Stoffbezug.

Die Basis dieses Produkts kann nicht mit folgenden Stoffen hergestellt werden: Velvet, Gary, Hunt, Kabuki, Kerlin, Leopold, Tibet Square, Timothy.

KOPFSTÜTZE

Aus Sperrholz mit Beschichtung aus PU-Schaum mit hoher Dichte, Polsterung mit atmungsaktiver temperaturregulierter Faser und Bezug aus weißer Baumwolle. Damit die Kopfstütze perfekt an der Sitzfläche anliegt, befindet sich im Band auf Höhe des Sitzkissens ein Gegengewicht. Der Bezug kann auf Wunsch mit Stoff oder Leder aus der Musterkollektion ausgeführt werden. Wenn bei der Bestellung keine Angaben gemacht werden, wird der gleiche Bezug wie für das Sofa verwendet. Rutschfestes Gewebe am Boden des Elements. Komplett abziehbar.

Déhoussage : structure, coussins d'assise et de dossier entièrement déhoussables dans toutes les versions (tissu ou cuir).

Piètements : portants, en aluminium extrudé peint couleur Bronze ou Étain brillant anti-traces de doigt. Patins glisseurs en polyéthylène de couleur bronze ou noire, selon la finition choisie pour le piètement.

Pour permettre le déhoussage, les éléments dossier/accoudoir et les tablettes (le cas échéant) sont faciles à retirer de leur logement en tournant les poignées prévues à cet effet et situées sous la structure portante. Si nécessaire, cette opération peut également être effectuée pour faciliter le transport et la livraison.

PRÉCISIONS CONCERNANT LA CONFECTION DU REVÊTEMENT

A) Revêtement entièrement en tissu ou en cuir ;

B) Revêtement du piètement en cuir cat. Cuir Nature, coussins d'assise et de dossier en tissu.

Il n'est pas possible de réaliser le piètement de ce produit dans les tissus suivants : Velvet, Gary, Hunt, Kabuki, Kerlin, Leopold, Tibet Square, Timothy.

APPUI-TÊTE

Fabriqué en multiplis recouvert de polyuréthane expansé haute densité, puis de fibre thermocollée respirante doublée de toile de coton blanche. Pour améliorer l'adhérence de l'élément à l'assise, un contrepoids a été inséré à l'intérieur de la bande, au niveau du coussin d'assise. La housse peut être confectionnée au choix dans les tissus ou les cuirs de la collection, elle sera assortie au revêtement du canapé si le choix n'est pas spécifié lors de la commande. Tissu antidérapant sur le bas. Entièrement déhoussable.

BASI BASES

ALLUMINIO LUCIDO POLISHED ALUMINIUM

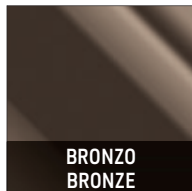

BRONZO
BRONZE

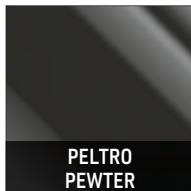

PELTRO
PEWTER

PIANI D'APPOGGIO TABLE-TOPS

FRASSINO ASH



MOKA

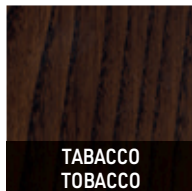

TABACCO
TOBACCO

Minotti

MODULO DI SEDUTA **CM 77**
SEAT CUSHION **CM 77**

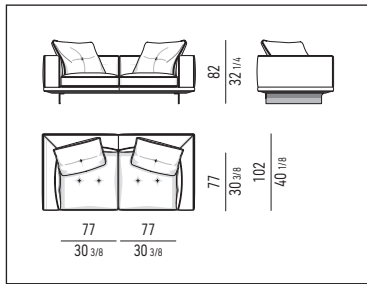

MODULO DI SEDUTA **CM 68**
SEAT CUSHION **CM 68**

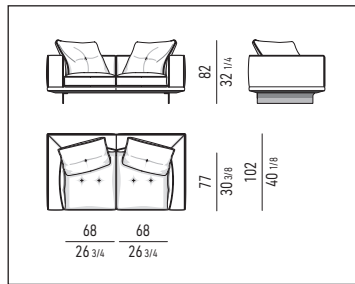

MODULO DI SEDUTA **ELEMENTI ANGOLARI CM 68/77**
CORNER ELEMENTS SEAT CUSHION CM 68/77

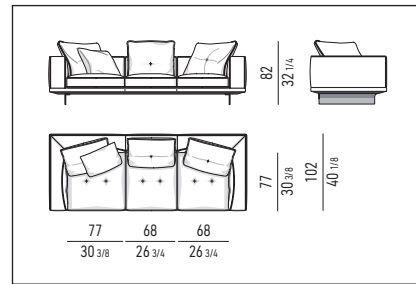

MODULO DI SEDUTA **ELEMENTI LOUNGE THEATRE CM 57**
LOUNGE THEATRE ELEMENTS SEAT CUSHION CM 57

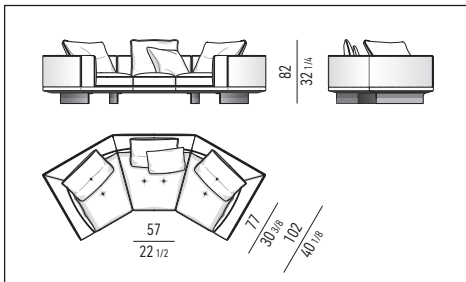

ANGOLO ELEMENTI INCLINATI / LOUNGE THEATRE
ANGLE INCLINED ELEMENTS / LOUNGE THEATRE

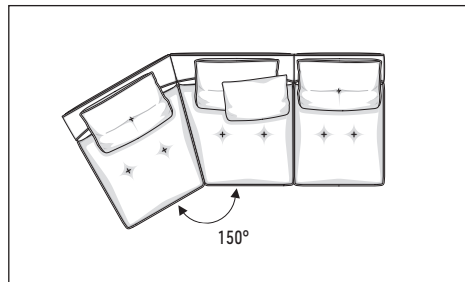

PIANI D'APPOGGIO PER ELEMENTI CON MODULO DI SEDUTA CM 77
TABLE-TOPS FOR ELEMENTS WITH SEAT CUSHION CM 77

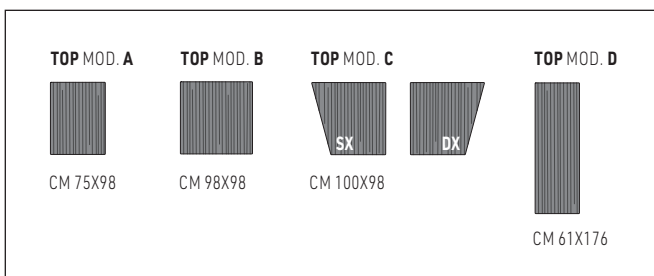

PIANI D'APPOGGIO PER ELEMENTI CON MODULO DI SEDUTA CM 68
TABLE-TOPS FOR ELEMENTS WITH SEAT CUSHION CM 68

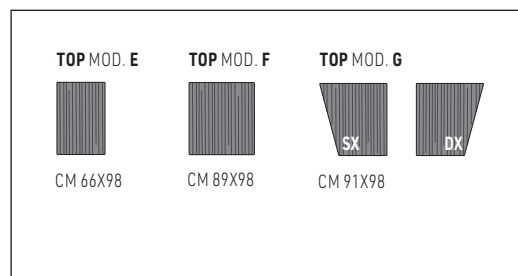

MODULO DI SEDUTA 77 CM | SEAT CUSHION 77 CM

DIVANI | SOFAS

DIVANO **CM 204**
SOFA **CM 204**

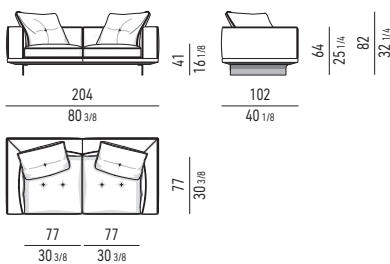

DIVANO **CM 283**
SOFA **CM 283**

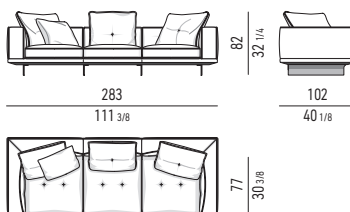

DIVANO OPEN **CM 283**
OPEN SOFA **CM 283**

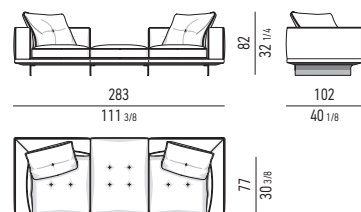

DIVANI DAYBED | DAYBED SOFAS

DIVANO DAYBED **CM 204**
DAYBED SOFA **CM 204**

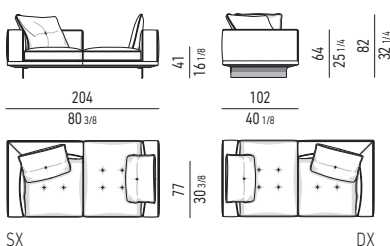

DIVANO DAYBED **CM 283**
DAYBED SOFA **CM 283**

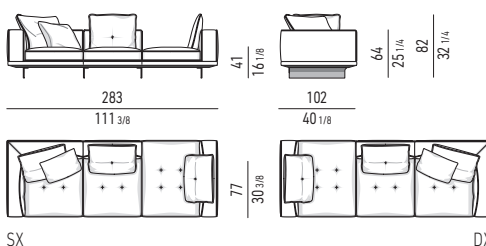

ELEMENTI DAYBED | DAYBED ELEMENTS

ELEMENTO DAYBED CM 181
DAYBED ELEMENT CM 181

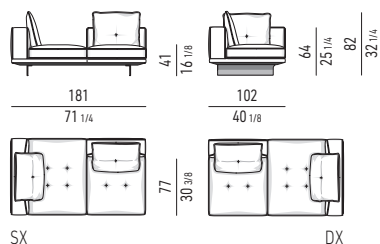

ELEMENTO DAYBED CM 260
DAYBED ELEMENT CM 260

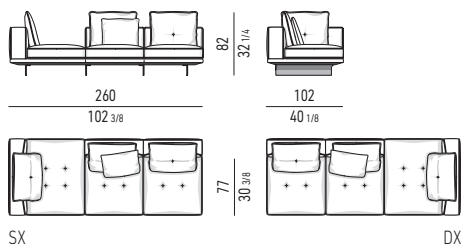

ELEMENTI TERMINALI | ELEMENTS WITH 1 ARMREST

ELEMENTO ANGOLARE TERMINALE CM 102
CORNER ELEMENT WITH 1 ARMREST CM 102

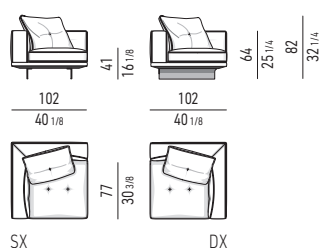

ELEMENTO TERMINALE CM 181
ELEMENT WITH 1 ARMREST CM 181

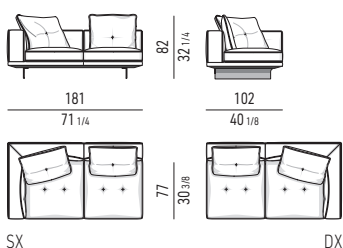

ELEMENTO TERMINALE CM 260
ELEMENT WITH 1 ARMREST CM 260

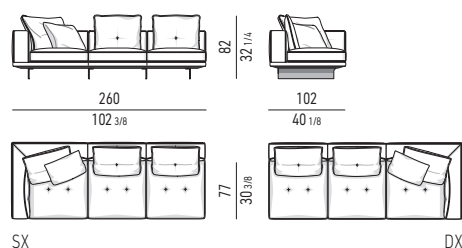

ELEMENTO TERMINALE OPEN CM 260
OPEN ELEMENT WITH 1 ARMREST CM 260

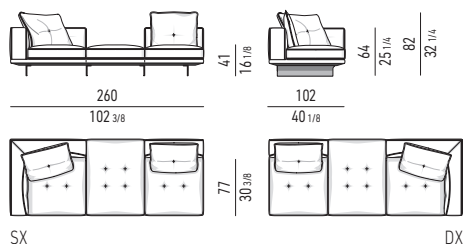

ELEMENTI TERMINALI CON TOP | ELEMENTS WITH 1 ARMREST WITH TOP

ELEMENTO TERMINALE CM 260 CON TOP A
ELEMENT WITH ARMREST CM 260 WITH TOP A

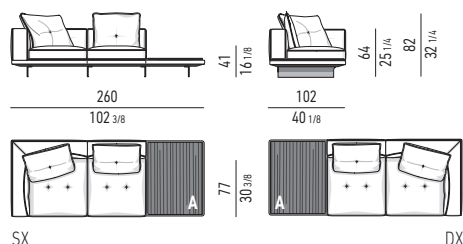

ELEMENTO TERMINALE CM 283 CON TOP B
ELEMENT WITH ARMREST CM 283 WITH TOP B

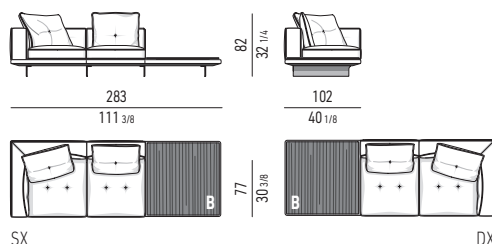

ELEMENTI TERMINALI PENISOLA | OPEN-END ELEMENTS WITH ARMREST

ELEMENTO TERMINALE PENISOLA CM 181
OPEN-END ELEMENT WITH ARMREST CM 181

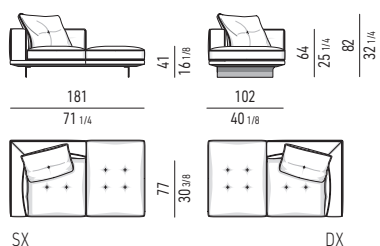

ELEMENTO TERMINALE PENISOLA CM 204
OPEN-END ELEMENT WITH ARMREST CM 204

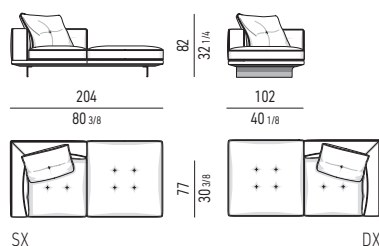

ELEMENTO TERMINALE PENISOLA CM 260
OPEN-END ELEMENT WITH ARMREST CM 260

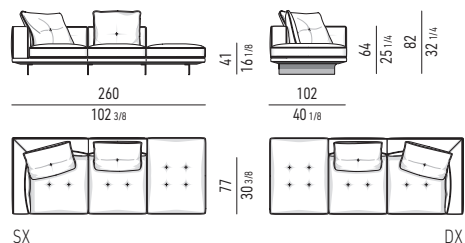

ELEMENTO TERMINALE PENISOLA CM 283
OPEN-END ELEMENT WITH ARMREST CM 283

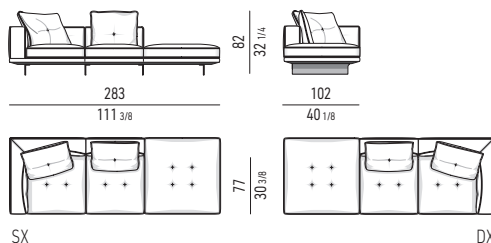

ELEMENTI CENTRALI | CENTRAL ELEMENTS

ELEMENTO CENTRALE CM 79
CENTRAL ELEMENT CM 79

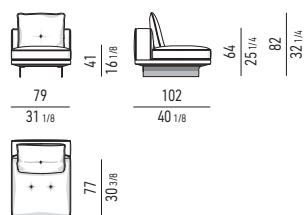

ELEMENTO CENTRALE CM 158
CENTRAL ELEMENT CM 158

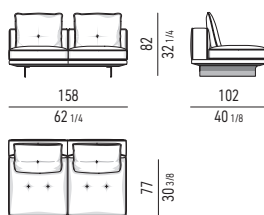

ELEMENTO CENTRALE CM 237
CENTRAL ELEMENT CM 237

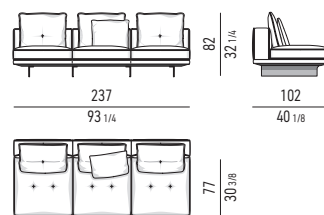

ELEMENTI CENTRALI CON TOP | CENTRAL ELEMENTS WITH TOP

ELEMENTO CENTRALE OPEN CM 237
OPEN CENTRAL ELEMENT CM 237

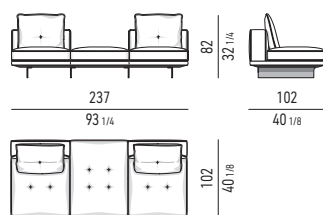

ELEMENTO CENTRALE CM 158 CON TOP A
CENTRAL ELEMENT CM 158 WITH TOP A

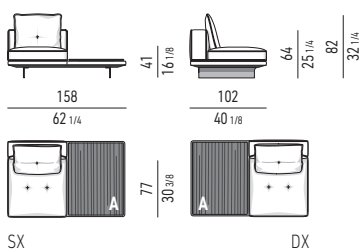

ELEMENTO CENTRALE CM 181 CON TOP B
CENTRAL ELEMENT CM 181 WITH TOP B

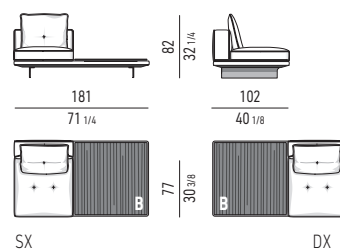

ELEMENTO CENTRALE CM 237 CON TOP A
CENTRAL ELEMENT CM 237 WITH TOP A

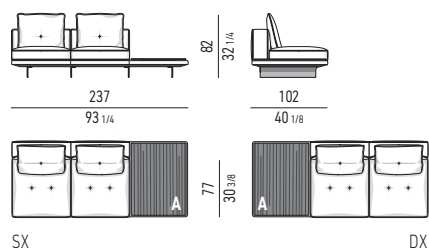

ELEMENTO CENTRALE CM 260 CON TOP B
CENTRAL ELEMENT CM 260 WITH TOP B

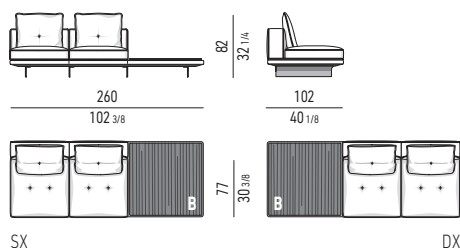

ELEMENTI PENISOLA | OPEN-END ELEMENTS

ELEMENTO PENISOLA CM 158
OPEN-END ELEMENT CM 158

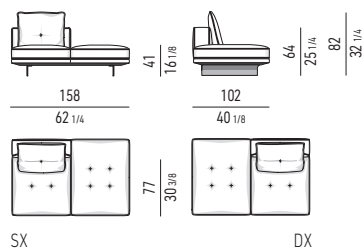

ELEMENTO PENISOLA CM 181
OPEN-END ELEMENT CM 181

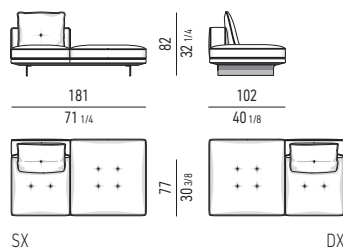

Minotti

ELEMENTO PENISOLA CM 237
OPEN-END ELEMENT CM 237

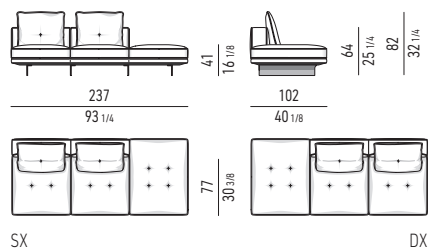

ELEMENTO PENISOLA CM 260
OPEN-END ELEMENT CM 260

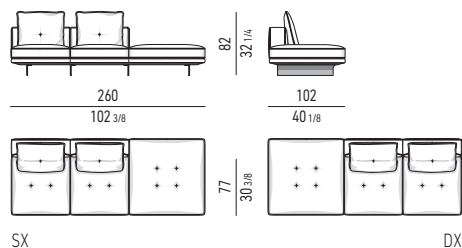

COUCHES

COUCH CM 79X158
COUCH CM 79X158

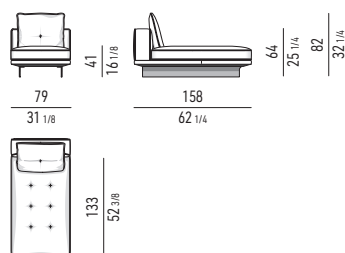

COUCH CM 117X140 - SCHIENALE UNICO
COUCH CM 117X140 - SINGLE BACKREST

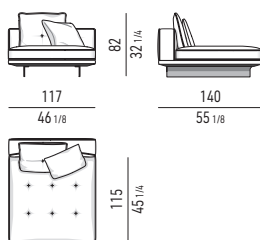

DOPPIO COUCH CM 158X158
DOUBLE COUCH CM 158X158

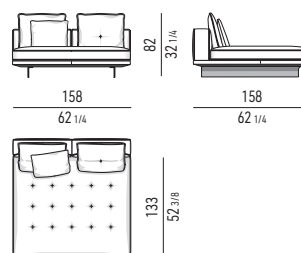

DOPPIO COUCH CM 158X181
DOUBLE COUCH CM 158X181

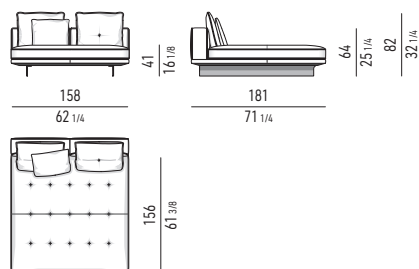

COUCH CM 181X181 CON TOP D
COUCH CM 181X181 WITH TOP D

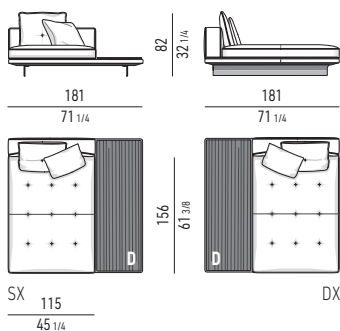

CHAISE-LONGUES

CHAISE-LONGUE CM 140X140 - SCHIENALE UNICO
CHAISE-LONGUE CM 140X140 - SINGLE BACKREST

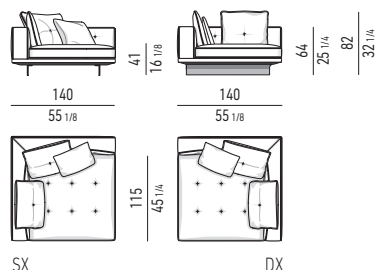

CHAISE-LONGUE CM 181X181
CHAISE-LONGUE CM 181X181

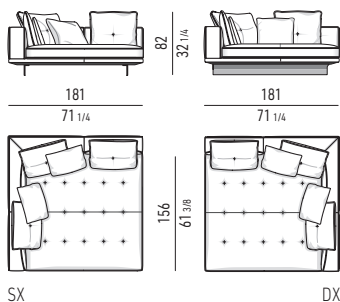

DIVANI INCLINATI | INCLINED SOFAS

DIVANO INCLINATO CM **238X152**
INCLINED SOFA CM **238X152**

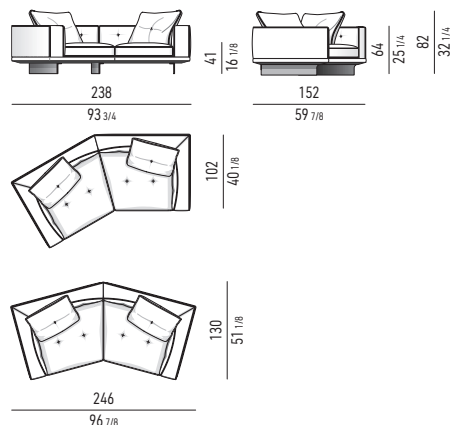

DIVANO INCLINATO CM **317X152**
INCLINED SOFA CM **317X152**

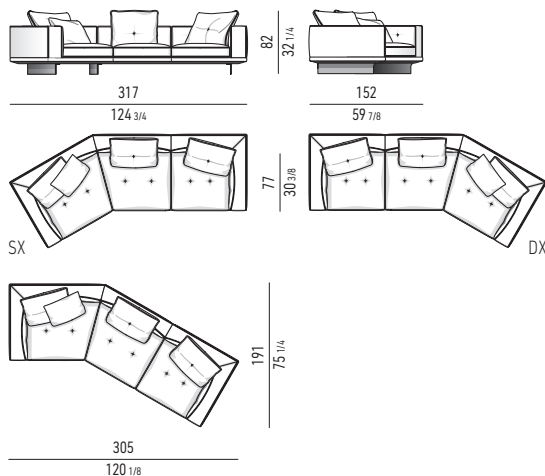

ELEMENTI TERMINALI INCLINATI | INCLINED ELEMENTS WITH ARMREST

ELEMENTO TERMINALE INCLINATO CM **215X152**
INCLINED ELEMENT WITH ARMREST CM **215X152**

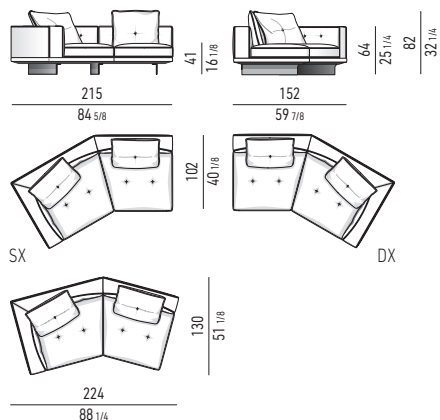

ELEMENTO TERMINALE INCLINATO CM **294X152**
INCLINED ELEMENT WITH ARMREST CM **294X152**

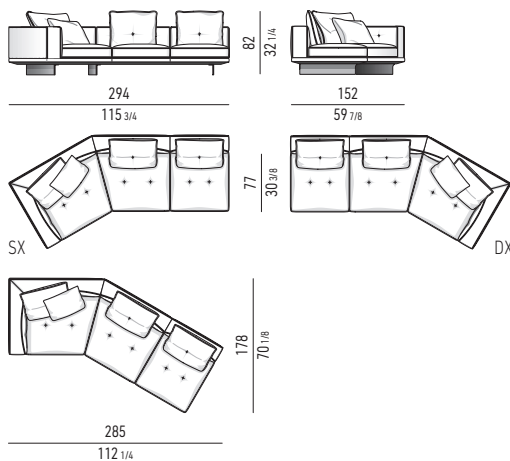

ELEMENTO TERMINALE INCLINATO CM **296X140**
INCLINED ELEMENT WITH ARMREST CM **296X140**

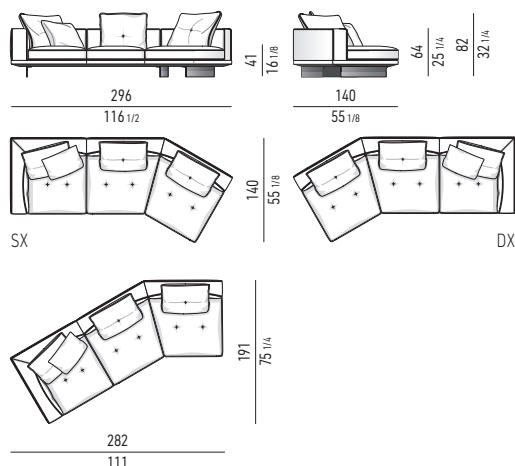

ELEMENTI TERMINALI INCLINATI CON TOP | INCLINED ELEMENTS WITH ARMREST AND TOP

ELEMENTO TERMINALE INCLINATO CM **294X152 CON TOP A**
INCLINED ELEMENT WITH ARMREST CM **294X152 WITH TOP A**

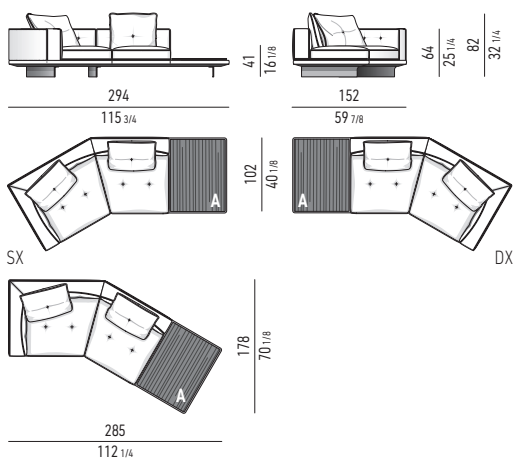

ELEMENTO TERMINALE INCLINATO CM 317X152 CON TOP B
INCLINED ELEMENT WITH ARMREST CM 317X152 WITH TOP B

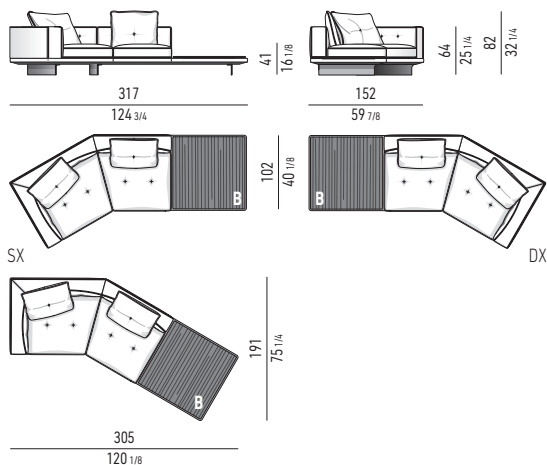

ELEMENTO TERMINALE INCLINATO CM 296X140 CON TOP C
INCLINED ELEMENT WITH ARMREST CM 296X140 WITH TOP C

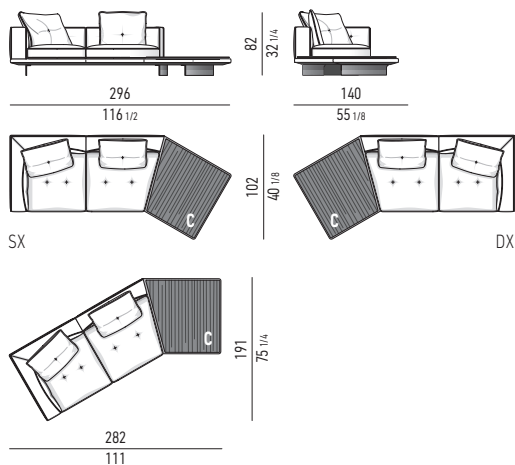

ELEMENTI CENTRALI INCLINATI | INCLINED CENTRAL ELEMENTS

ELEMENTO CENTRALE INCLINATO CM 194X140
INCLINED CENTRAL ELEMENT CM 194X140

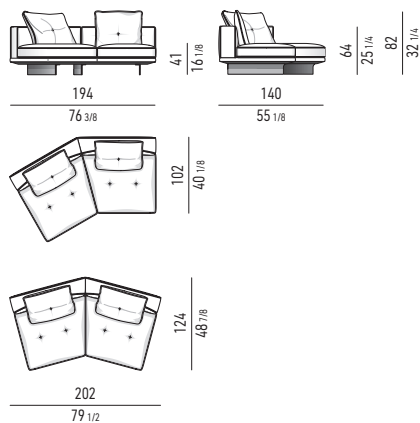

ELEMENTO CENTRALE INCLINATO CM 273X140
INCLINED CENTRAL ELEMENT CM 273X140

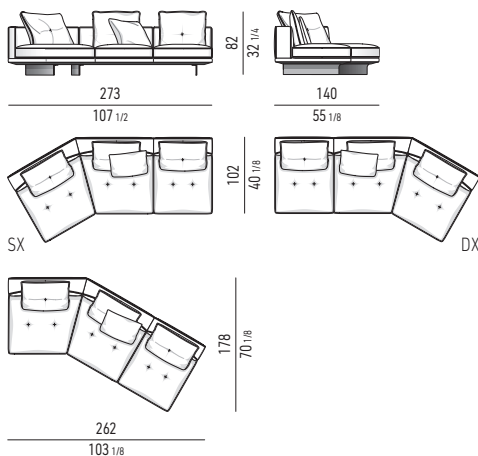

ELEMENTI CENTRALI INCLINATI CON TOP | INCLINED CENTRAL ELEMENTS WITH TOP

ELEMENTO CENTRALE INCLINATO CM 194X140 CON TOP C
INCLINED CENTRAL ELEMENT CM 194X140 WITH TOP C

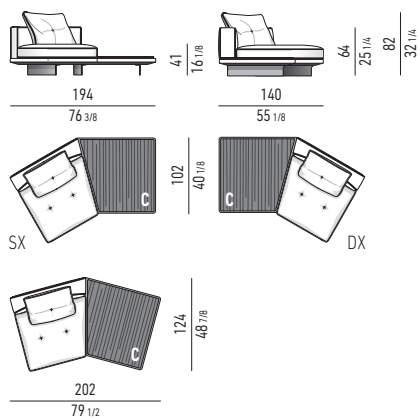

ELEMENTO CENTRALE INCLINATO CM 273X140 CON TOP A
INCLINED CENTRAL ELEMENT CM 273X140 WITH TOP A

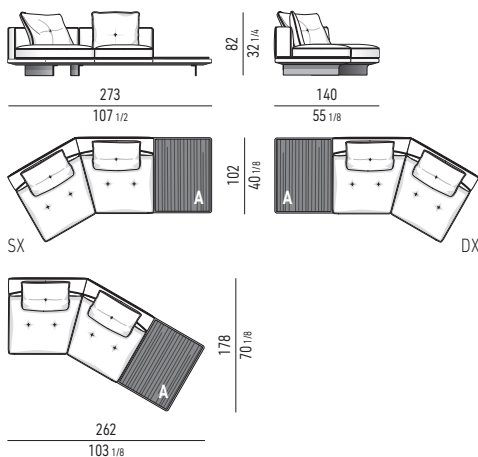

Minotti

ELEMENTO CENTRALE INCLINATO CM 296X140 CON TOP B
INCLINED CENTRAL ELEMENT CM 296X140 WITH TOP B

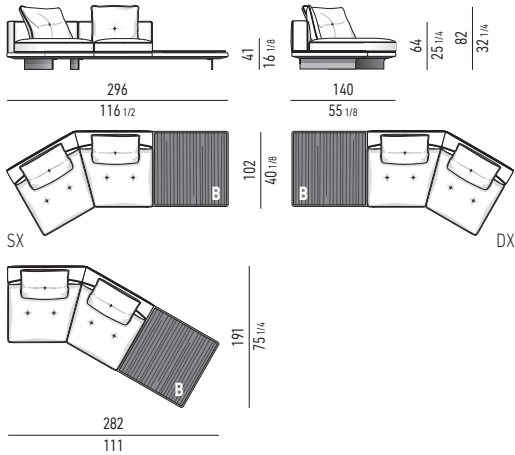

ELEMENTO CENTRALE INCLINATO CM 273X140 CON TOP C
INCLINED CENTRAL ELEMENT CM 273X140 WITH TOP C

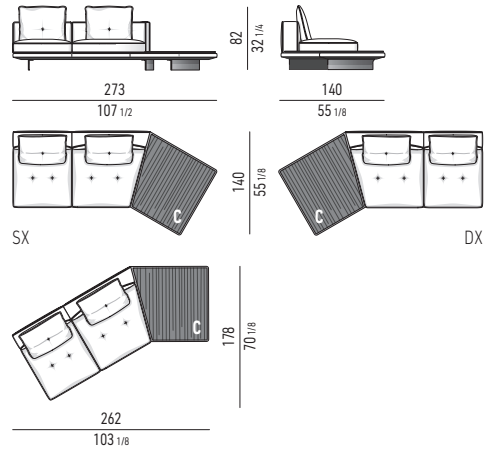

ELEMENTI "THEATRE" | "THEATRE" ELEMENTS *

* N.B.: IL LATO CON MISURA INDICATA 106 CM PUÒ ESSERE UTILIZZATO SOLO IN COMPOSIZIONE CON ALTRI ELEMENTI THEATRE.
N.B.: THE 106 CM SIDE CAN BE USED TO JOIN ONLY OTHER THEATRE ELEMENTS.

ELEMENTO TERMINALE THEATRE CM 127
THEATRE ELEMENT WITH 1 ARMREST CM 127

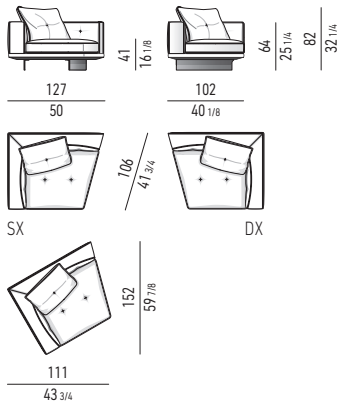

ELEMENTO TERMINALE THEATRE CM 206
THEATRE ELEMENT WITH 1 ARMREST CM 206

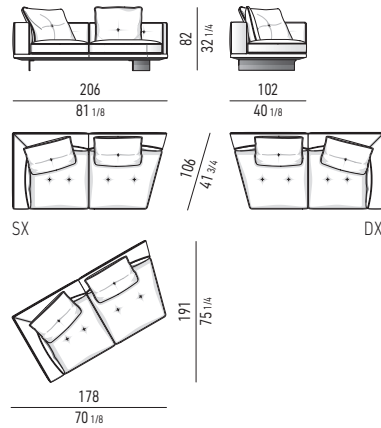

ELEMENTO TERMINALE THEATRE CM 285
THEATRE ELEMENT WITH 1 ARMREST CM 285

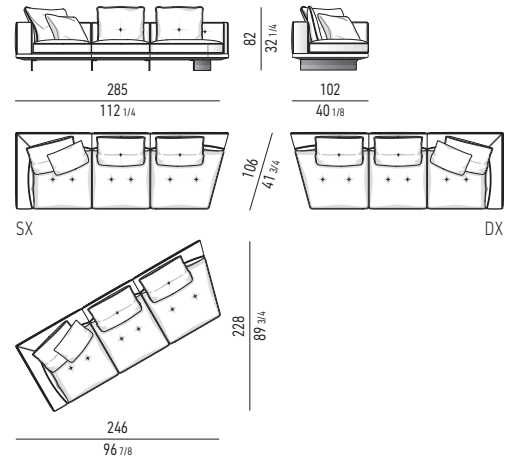

ELEMENTO CENTRALE SIMMETRICO THEATRE CM 129
THEATRE SYMMETRICAL CENTRAL ELEMENT CM 129

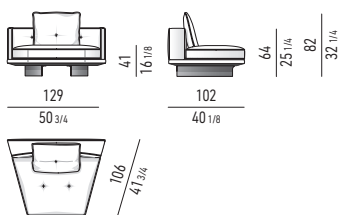

ELEMENTO CENTRALE SIMMETRICO THEATRE CM 208
THEATRE SYMMETRICAL CENTRAL ELEMENT CM 208

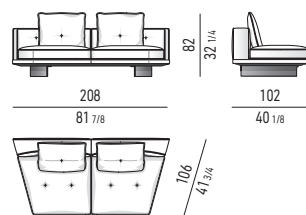

ELEMENTO CENTRALE SIMMETRICO THEATRE CM 287
THEATRE SYMMETRICAL CENTRAL ELEMENT CM 287

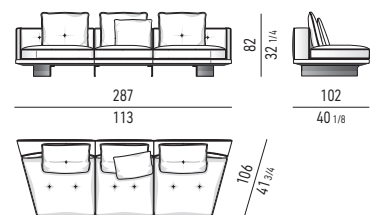

ELEMENTO CENTRALE ASIMMETRICO THEATRE CM 104
THEATRE ASYMMETRICAL CENTRAL ELEMENT CM 104

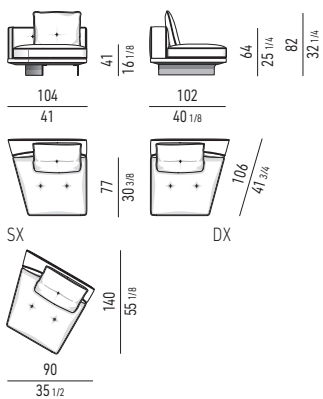

ELEMENTO CENTRALE ASIMMETRICO THEATRE CM 183
THEATRE ASYMMETRICAL CENTRAL ELEMENT CM 183

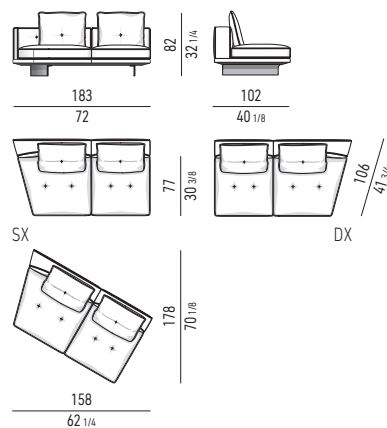

ELEMENTO CENTRALE ASIMMETRICO THEATRE CM 262
THEATRE ASYMMETRICAL CENTRAL ELEMENT CM 262

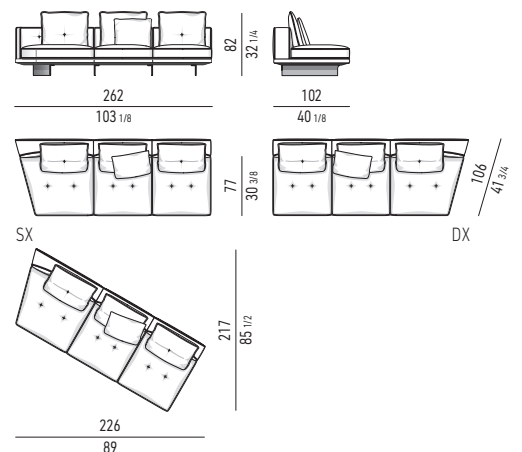

Minotti

ELEMENTO CENTRALE ASIMMETRICO **THEATRE CM 183** CON **TOP A**
THEATRE ASYMMETRICAL CENTRAL ELEMENT CM 183 WITH **TOP A**

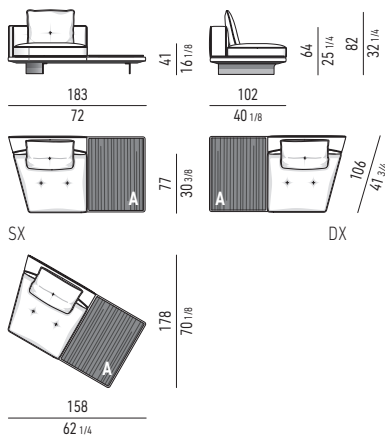

ELEMENTO CENTRALE ASIMMETRICO **THEATRE CM 262** CON **TOP A**
THEATRE ASYMMETRICAL CENTRAL ELEMENT CM 262 WITH **TOP A**

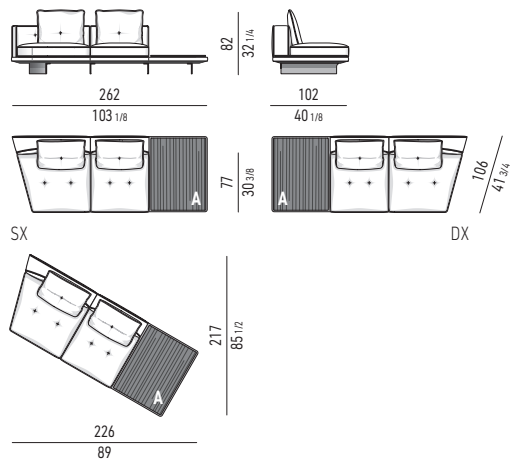

ELEMENTO CENTRALE ASIMMETRICO **THEATRE CM 206** CON **TOP B**
THEATRE ASYMMETRICAL CENTRAL ELEMENT CM 206 WITH **TOP B**

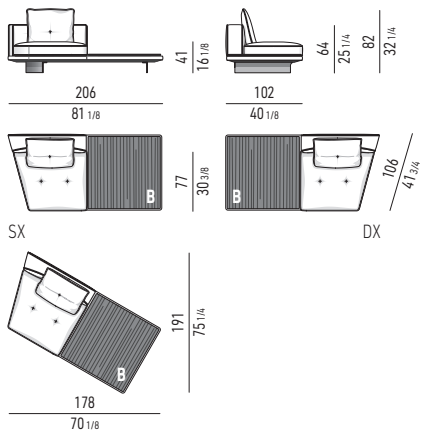

ELEMENTO CENTRALE ASIMMETRICO **THEATRE CM 285** CON **TOP B**
THEATRE ASYMMETRICAL CENTRAL ELEMENT CM 285 WITH **TOP B**

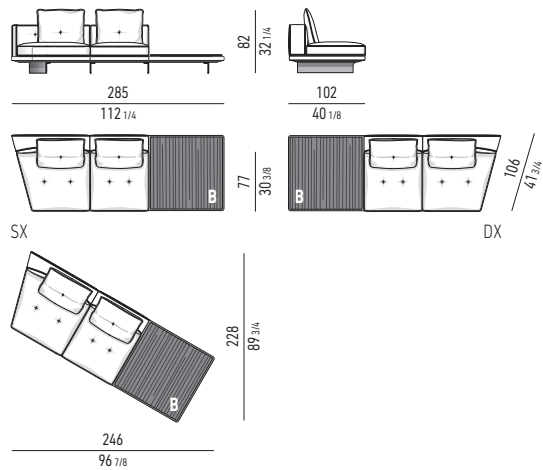

MODULO DI SEDUTA 68 CM | SEAT CUSHION 68 CM

DIVANI | SOFAS

DIVANO CM **186**
 SOFA CM **186**

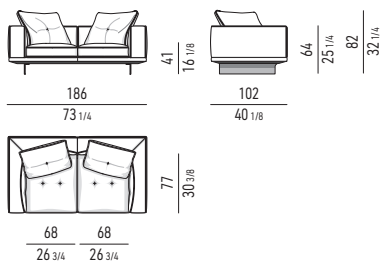

DIVANO CM **256**
 SOFA CM **256**

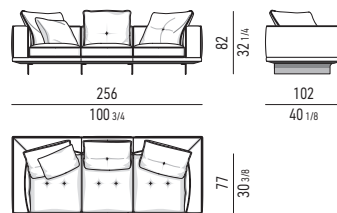

DIVANO OPEN CM **256**
 OPEN SOFA CM **256**

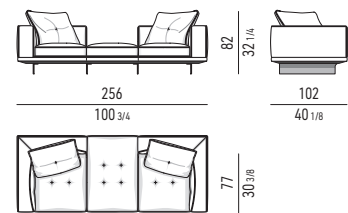

DIVANI DAYBED | DAYBED SOFAS

DIVANO DAYBED CM **186**
 DAYBED SOFA CM **186**

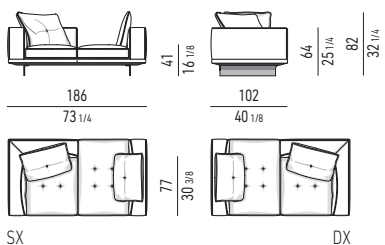

DIVANO DAYBED CM **256**
 DAYBED SOFA CM **256**

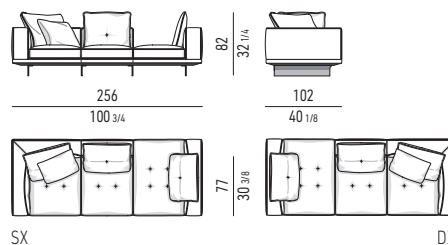

Minotti

ELEMENTI DAYBED | DAYBED ELEMENTS

ELEMENTO DAYBED CM 163
DAYBED ELEMENT CM 163

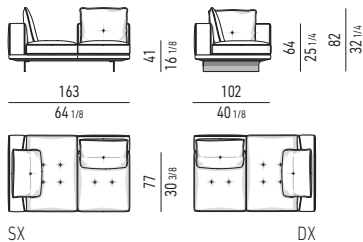

ELEMENTO DAYBED CM 233
DAYBED ELEMENT CM 233

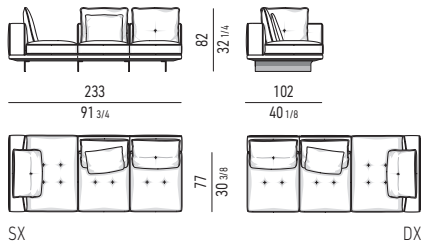

ELEMENTI TERMINALI | ELEMENTS WITH 1 ARMREST

ELEMENTO TERMINALE CM 93
ELEMENT WITH 1 ARMREST CM 93

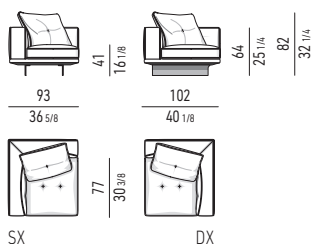

ELEMENTO TERMINALE CM 163
ELEMENT WITH 1 ARMREST CM 163

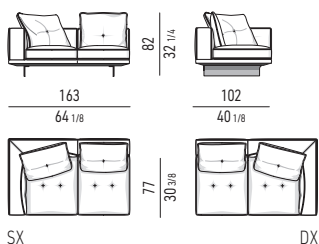

ELEMENTO TERMINALE CM 233
ELEMENT WITH 1 ARMREST CM 233

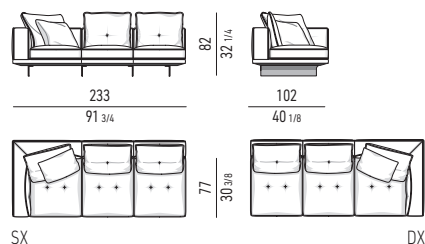

ELEMENTO TERMINALE OPEN CM 233
OPEN ELEMENT WITH ARMREST CM 233

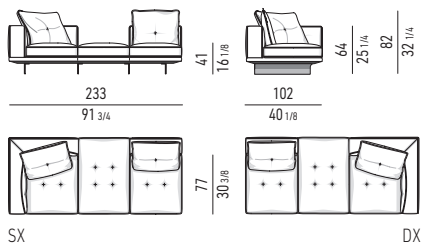

ELEMENTO TERMINALE CM 233 CON TOP E
ELEMENT WITH 1 ARMREST CM 233 WITH TOP E

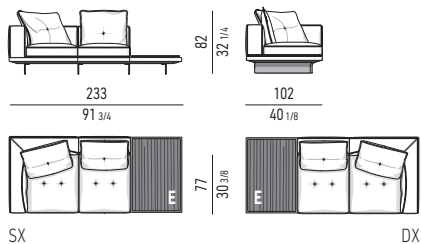

ELEMENTO TERMINALE CM 256 CON TOP F
ELEMENT WITH 1 ARMREST CM 256 WITH TOP F

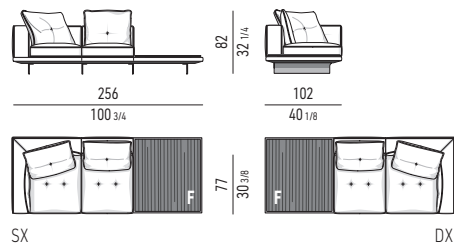

ELEMENTI TERMINALI PENISOLA | OPEN-END ELEMENTS WITH ARMREST

ELEMENTO TERMINALE PENISOLA CM 163
OPEN-END ELEMENT WITH ARMREST CM 163

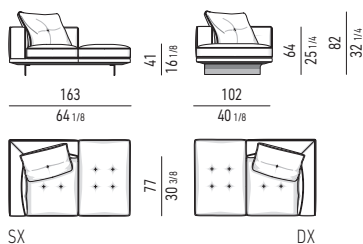

ELEMENTO TERMINALE PENISOLA CM 233
OPEN-END ELEMENT WITH ARMREST CM 233

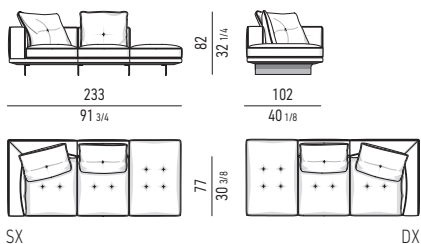

ELEMENTO TERMINALE PENISOLA CM 186
OPEN-END ELEMENT WITH ARMREST CM 186

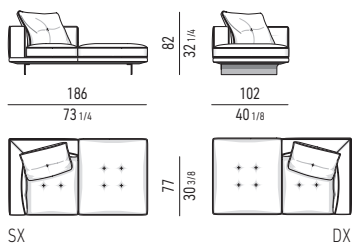

ELEMENTO TERMINALE PENISOLA CM 256
OPEN-END ELEMENT WITH ARMREST CM 256

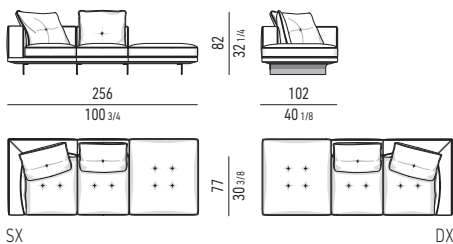

ELEMENTI CENTRALI | CENTRAL ELEMENTS

ELEMENTO CENTRALE CM 70
CENTRAL ELEMENT CM 70

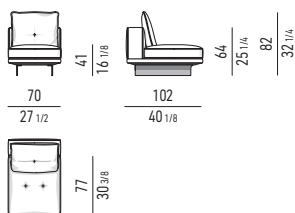

ELEMENTO CENTRALE CM 140
CENTRAL ELEMENT CM 140

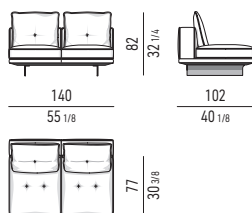

ELEMENTO CENTRALE CM 210
CENTRAL ELEMENT CM 210

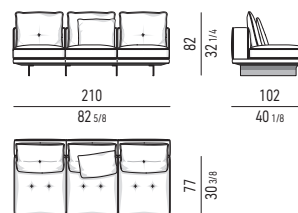

ELEMENTI CENTRALI CON TOP | CENTRAL ELEMENTS WITH TOP

ELEMENTO CENTRALE OPEN CM 210
OPEN CENTRAL ELEMENT CM 210

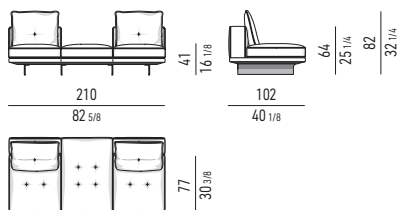

ELEMENTO CENTRALE CM 140 CON TOP E
CENTRAL ELEMENT CM 140 WITH TOP E

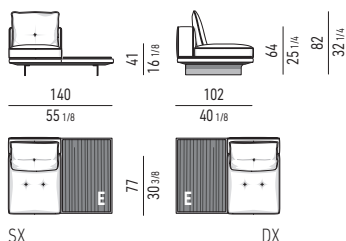

ELEMENTO CENTRALE CM 163 CON TOP F
CENTRAL ELEMENT CM 163 WITH TOP F

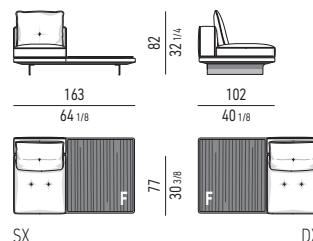

ELEMENTO CENTRALE CM 210 CON TOP E
CENTRAL ELEMENT CM 210 WITH TOP E

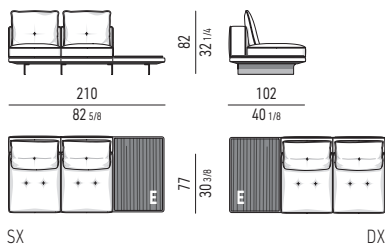

ELEMENTO CENTRALE CM 233 CON TOP F
CENTRAL ELEMENT CM 233 WITH TOP F

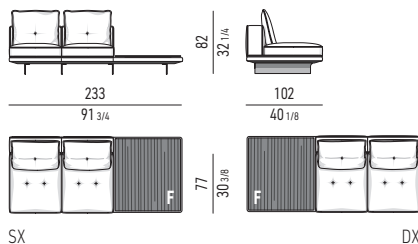

ELEMENTI PENISOLA | OPEN-END ELEMENTS

ELEMENTO PENISOLA CM 140
OPEN-END ELEMENT CM 140

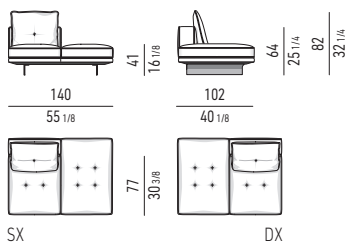

ELEMENTO PENISOLA CM 163
OPEN-END ELEMENT CM 163

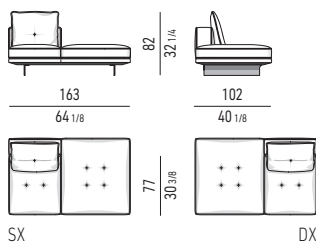

ELEMENTO PENISOLA CM 210
OPEN-END ELEMENT CM 210

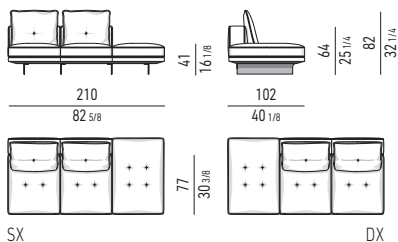

ELEMENTO PENISOLA CM 233
OPEN-END ELEMENT CM 233

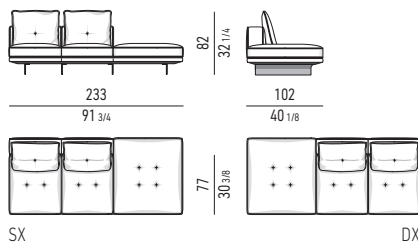

Minotti

COUCHES

COUCH CM 70X158
COUCH CM 70X158

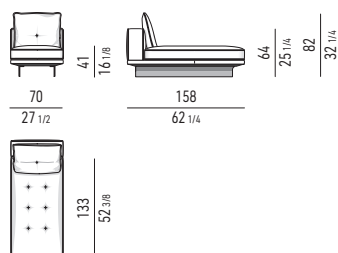

COUCH CM 117X140 - SCHIENALE UNICO
COUCH CM 117X140 - SINGLE BACKREST

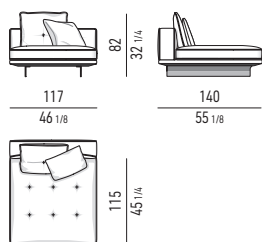

DOPPIO COUCH CM 140X158
DOUBLE COUCH CM 140X158

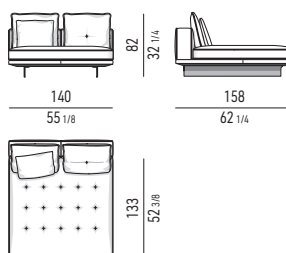

DOPPIO COUCH CM 140X181
DOUBLE COUCH CM 140X181

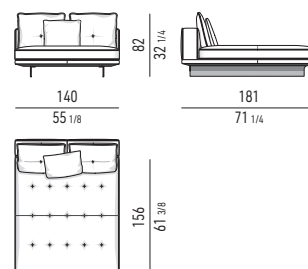

CHAISE-LONGUES

CHAISE-LONGUE CM 140X140 - SCHIENALE UNICO
CHAISE-LONGUE CM 140X140 - SINGLE BACKREST

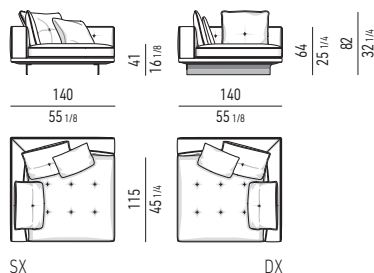

CHAISE-LONGUE CM 163X181
CHAISE-LONGUE CM 163X181

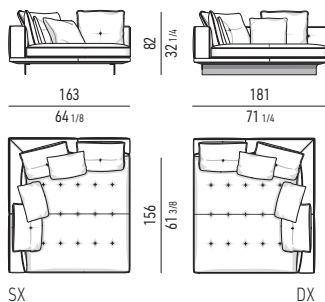

DIVANI INCLINATI | INCLINED SOFAS

DIVANO INCLINATO CM 221X147
INCLINED SOFA CM 221X147

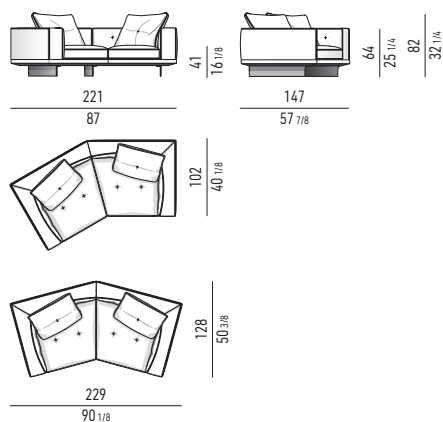

DIVANO INCLINATO CM 291X147
INCLINED SOFA CM 291X147

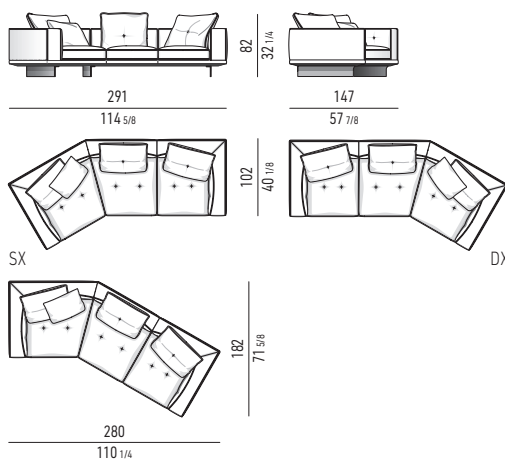

ELEMENTI TERMINALI INCLINATI | INCLINED ELEMENTS WITH ARMREST

ELEMENTO TERMINALE INCLINATO CM 198X147
INCLINED ELEMENT WITH ARMREST CM 198X147

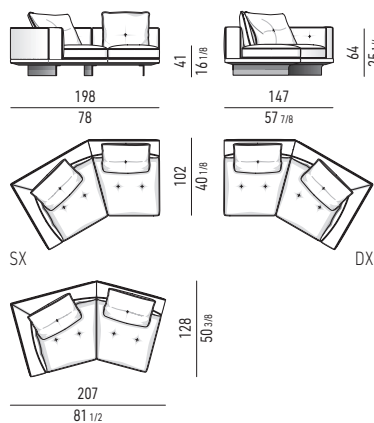

ELEMENTO TERMINALE INCLINATO CM 268X147
INCLINED ELEMENT WITH ARMREST CM 268X147

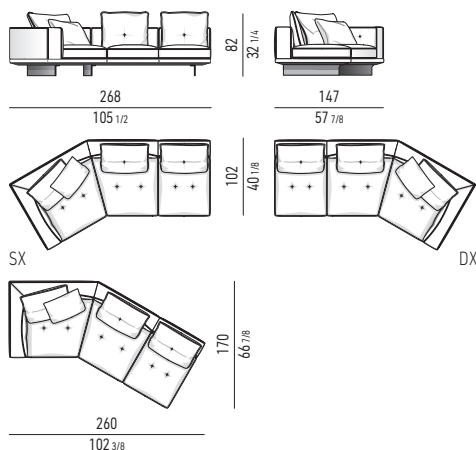

ELEMENTO TERMINALE INCLINATO CM 270X135 INCLINED ELEMENT WITH ARMREST CM 270X135

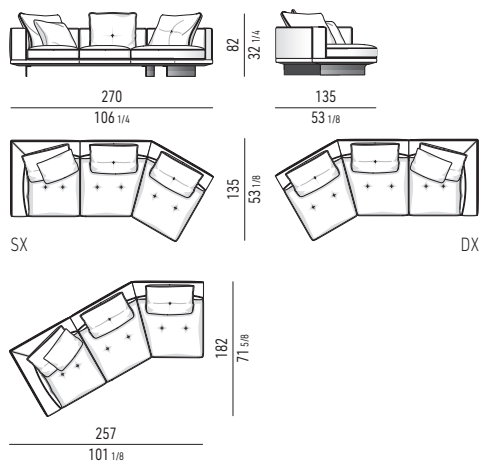

ELEMENTO TERMINALE INCLINATO CM 291X147 CON TOP F INCLINED ELEMENT WITH ARMREST CM 291X147 WITH TOP F

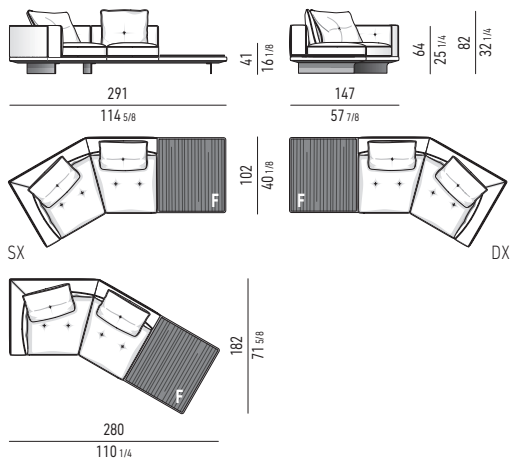

ELEMENTI CENTRALI INCLINATI | INCLINED CENTRAL ELEMENTS

ELEMENTO CENTRALE INCLINATO CM 177X135 INCLINED CENTRAL ELEMENT CM 177X135

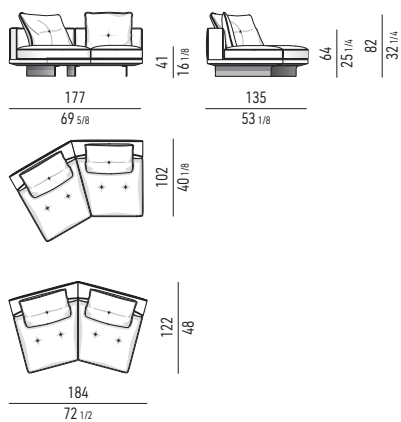

ELEMENTI TERMINALI INCLINATI CON TOP | INCLINED ELEMENTS WITH ARMREST AND TOP

ELEMENTO TERMINALE INCLINATO CM 268X147 CON TOP E INCLINED ELEMENT WITH ARMREST CM 268X147 WITH TOP E

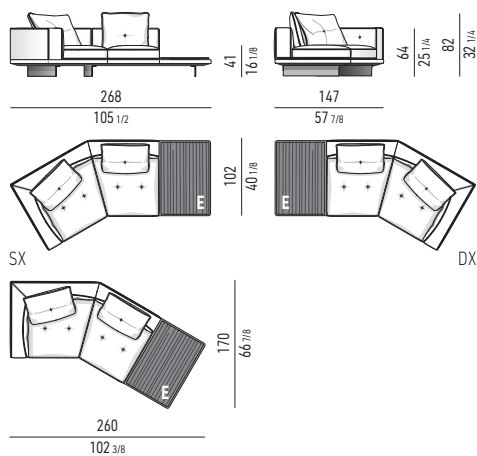

ELEMENTO TERMINALE INCLINATO CM 270X135 CON TOP G INCLINED ELEMENT WITH ARMREST CM 270X135 WITH TOP G

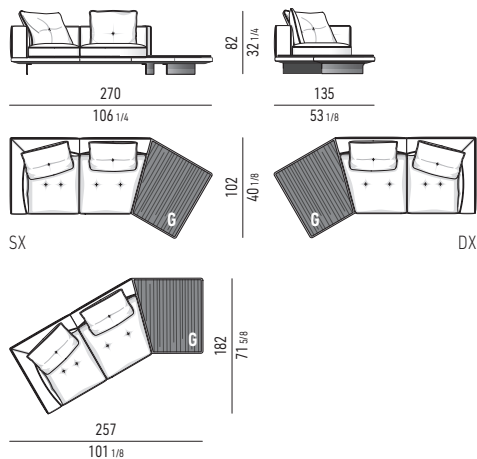

ELEMENTO CENTRALE INCLINATO CM 247X135 INCLINED CENTRAL ELEMENT CM 247X135

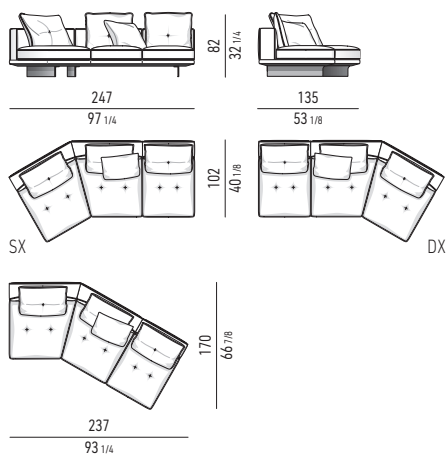

ELEMENTI CENTRALI INCLINATI CON TOP | INCLINED CENTRAL ELEMENTS WITH TOP

ELEMENTO CENTRALE INCLINATO CM 177X135 CON TOP G
INCLINED CENTRAL ELEMENT CM 177X135 WITH TOP G

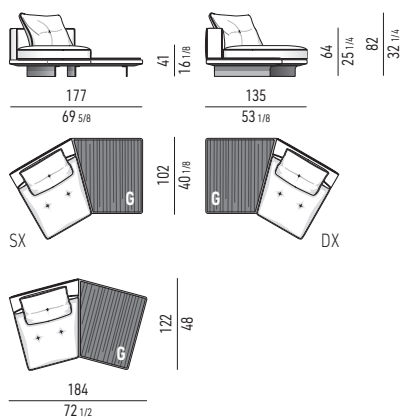

ELEMENTO CENTRALE INCLINATO CM 247X135 CON TOP E
INCLINED CENTRAL ELEMENT CM 247X135 WITH TOP E

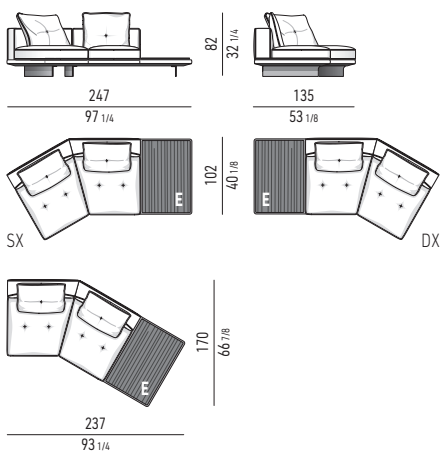

ELEMENTO CENTRALE INCLINATO CM 270X135 CON TOP F
INCLINED CENTRAL ELEMENT CM 270X135 WITH TOP F

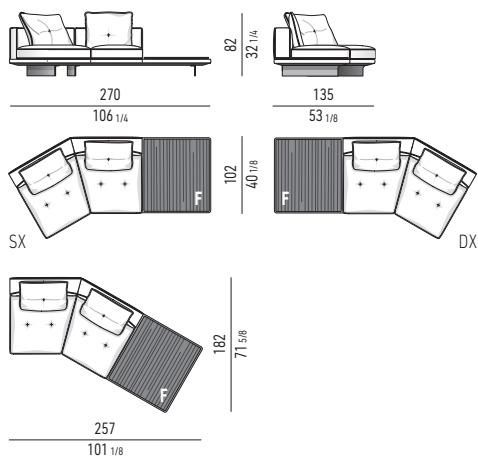

ELEMENTO CENTRALE INCLINATO CM 247X135 CON TOP G
INCLINED CENTRAL ELEMENT CM 247X135 WITH TOP G

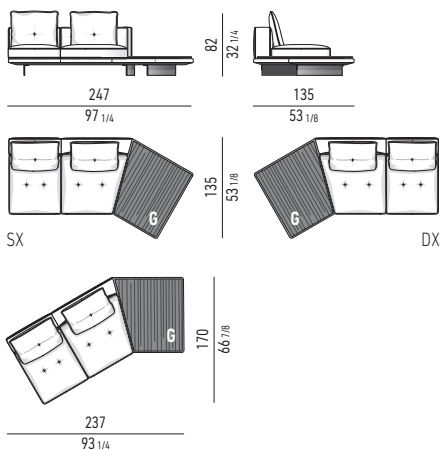

ELEMENTI "THEATRE" | "THEATRE" ELEMENTS *

* N.B.: IL LATO CON MISURA INDICATA 106 CM PUÒ ESSERE UTILIZZATO SOLO IN COMPOSIZIONE CON ALTRI ELEMENTI THEATRE.
N.B.: THE 106 CM SIDE CAN BE USED TO JOIN ONLY OTHER THEATRE ELEMENTS.

ELEMENTO TERMINALE THEATRE CM 118
THEATRE ELEMENT WITH 1 ARMREST CM 118

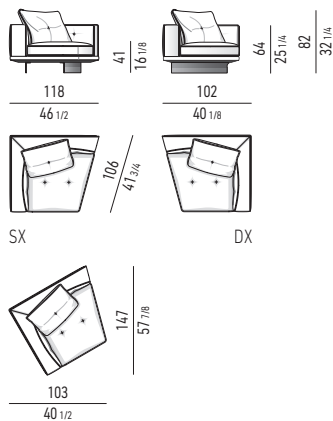

ELEMENTO TERMINALE THEATRE CM 188
THEATRE ELEMENT WITH 1 ARMREST CM 188

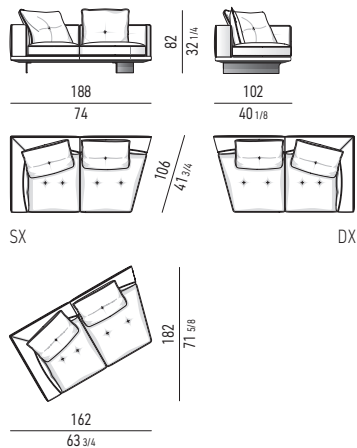

ELEMENTO TERMINALE THEATRE CM 258
THEATRE ELEMENT WITH 1 ARMREST CM 258

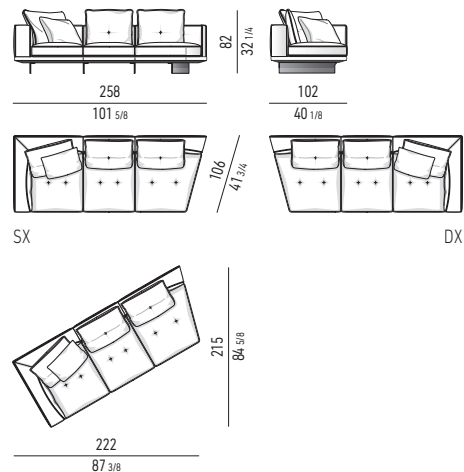

ELEMENTO CENTRALE SIMMETRICO **THEATRE CM 120**
THEATRE SYMMETRICAL CENTRAL ELEMENT CM 120

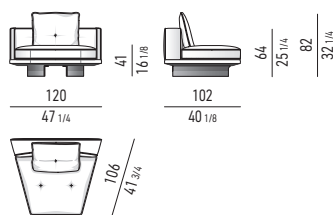

ELEMENTO CENTRALE SIMMETRICO **THEATRE CM 190**
THEATRE SYMMETRICAL CENTRAL ELEMENT CM 190

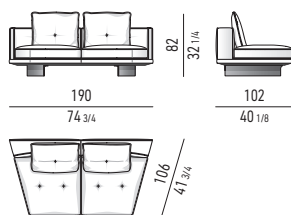

ELEMENTO CENTRALE SIMMETRICO **THEATRE CM 260**
THEATRE SYMMETRICAL CENTRAL ELEMENT CM 260

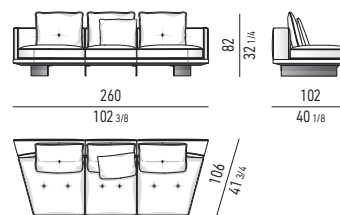

ELEMENTO CENTRALE ASIMMETRICO **THEATRE CM 95**
THEATRE ASYMMETRICAL CENTRAL ELEMENT CM 95

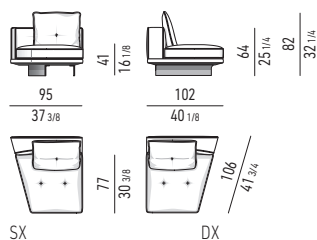

SX DX

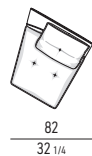

ELEMENTO CENTRALE ASIMMETRICO **THEATRE CM 165**
THEATRE ASYMMETRICAL CENTRAL ELEMENT CM 165

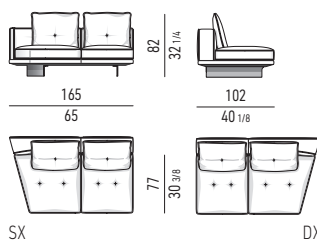

SX DX

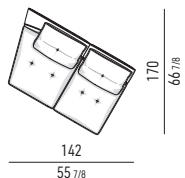

ELEMENTO CENTRALE ASIMMETRICO **THEATRE CM 235**
THEATRE ASYMMETRICAL CENTRAL ELEMENT CM 235

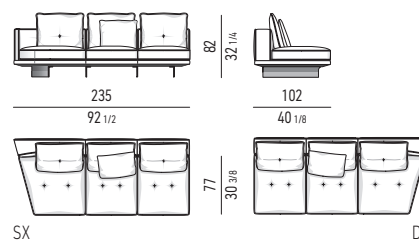

SX DX

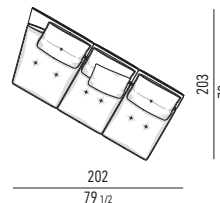

ELEMENTO CENTRALE ASIMMETRICO **THEATRE CM 165 CON TOP E**
THEATRE ASYMMETRICAL CENTRAL ELEMENT CM 165 WITH TOP E

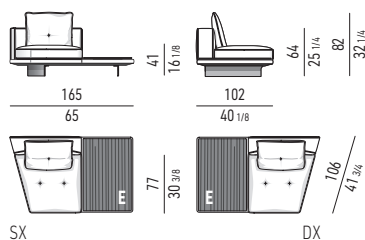

SX DX

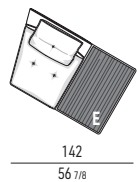

ELEMENTO CENTRALE ASIMMETRICO **THEATRE CM 235 CON TOP E**
THEATRE ASYMMETRICAL CENTRAL ELEMENT CM 235 WITH TOP E

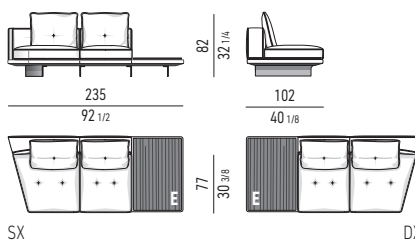

SX DX

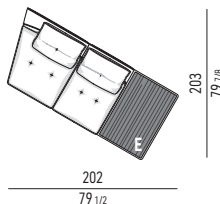

ELEMENTO CENTRALE ASIMMETRICO **THEATRE CM 188 CON TOP F**
THEATRE ASYMMETRICAL CENTRAL ELEMENT CM 188 WITH TOP F

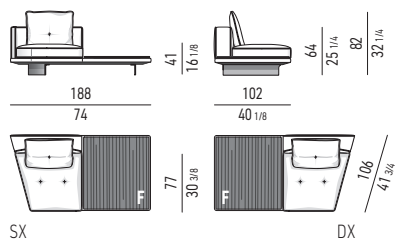

SX DX

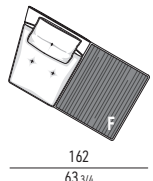

ELEMENTO CENTRALE ASIMMETRICO **THEATRE CM 258 CON TOP F**
THEATRE ASYMMETRICAL CENTRAL ELEMENT CM 258 WITH TOP F

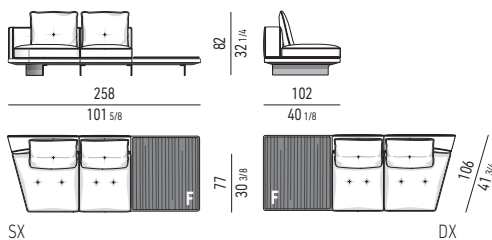

SX DX

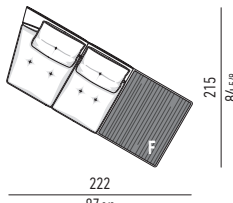

ELEMENTI ANGOLARI | CORNER ELEMENTS

DIVANI ANGOLARI | CORNER SOFAS

DIVANO ANGOLARE CM 265
CORNER SOFA CM 265

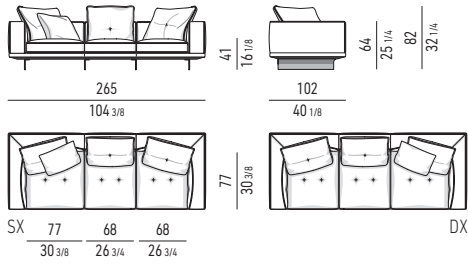

DIVANO ANGOLARE OPEN CM 265
CORNER OPEN SOFA CM 265

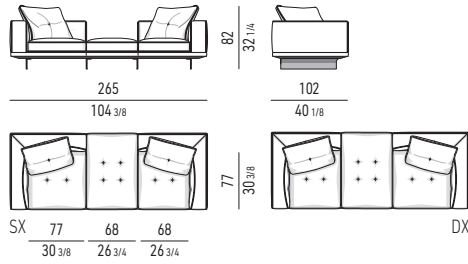

DIVANO ANGOLARE DAYBED CM 265
CORNER DAYBED SOFA CM 265

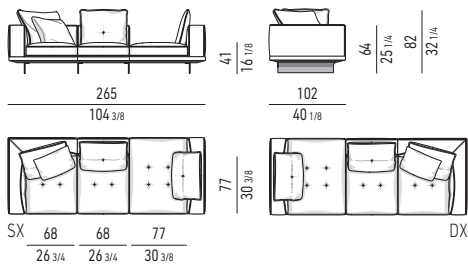

ELEMENTO ANGOLARE DAYBED | CORNER DAYBED ELEMENT

ELEMENTO ANGOLARE DAYBED CM 242
CORNER DAYBED ELEMENT CM 242

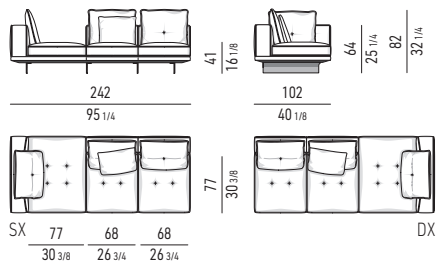

ELEMENTI ANGOLARI TERMINALI | CORNER ELEMENTS WITH ARMREST

ELEMENTO ANGOLARE TERMINALE CM 102
CORNER ELEMENT WITH ARMREST CM 102

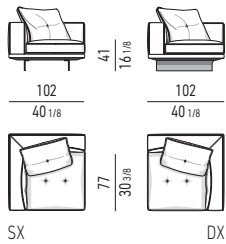

ELEMENTO ANGOLARE TERMINALE CM 242
CORNER ELEMENT WITH ARMREST CM 242

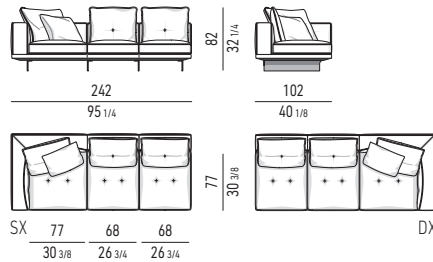

ELEMENTO ANGOLARE TERMINALE OPEN CM 242
CORNER OPEN ELEMENT WITH ARMREST CM 242

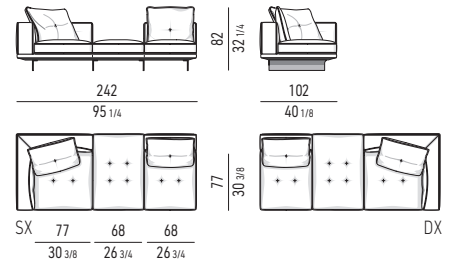

ELEMENTO ANGOLARE TERMINALE CM 242 CON TOP E
CORNER ELEMENT WITH ARMREST CM 242 WITH TOP E

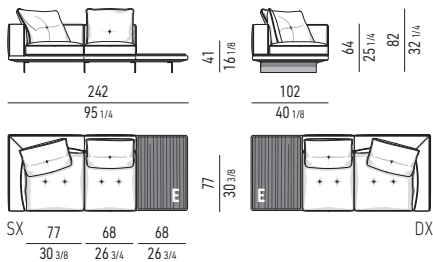

ELEMENTO ANGOLARE TERMINALE CM 265 CON TOP B
CORNER ELEMENT WITH ARMREST CM 265 WITH TOP B

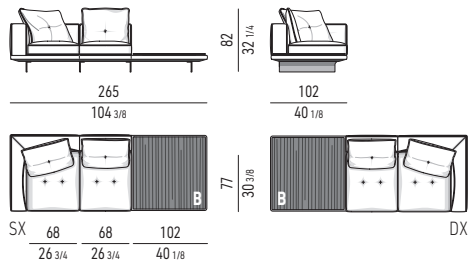

ELEMENTI ANGOLARI TERMINALI PENISOLA | CORNER OPEN-END ELEMENTS WITH ARMREST

ELEMENTO ANGOLARE TERMINALE PENISOLA CM 242
CORNER OPEN-END ELEMENT WITH ARMREST CM 242

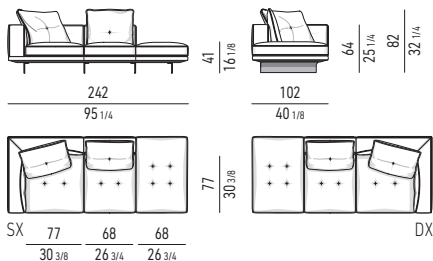

ELEMENTO ANGOLARE TERMINALE PENISOLA CM 265
CORNER OPEN-END ELEMENT WITH ARMREST CM 265

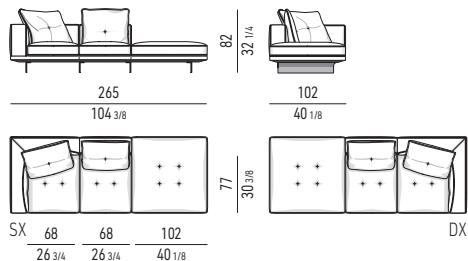

Minotti

POUF | OTTOMANS

POUF CM **59X79**
OTTOMAN CM **59X79**

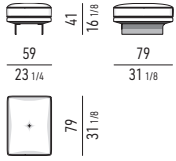

POUF CM **70X79**
OTTOMAN CM **70X79**

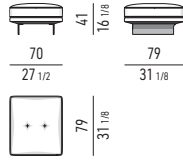

POUF CM **79X79**
OTTOMAN CM **79X79**

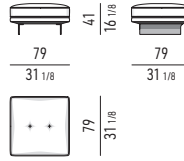

POUF CM **59X102**
OTTOMAN CM **59X102**

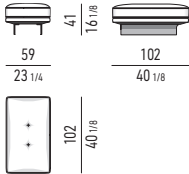

POUF CM **70X102**
OTTOMAN CM **70X102**

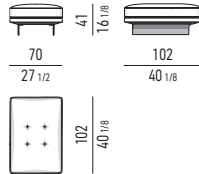

POUF CM **79X102**
OTTOMAN CM **79X102**

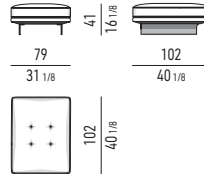

POUF CM **93X102**
OTTOMAN CM **93X102**

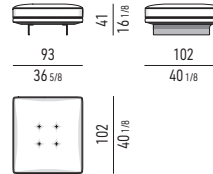

POUF CM **102X102**
OTTOMAN CM **102X102**

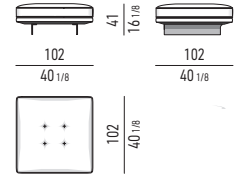

POUF CM **70X48**
OTTOMAN CM **70X48**

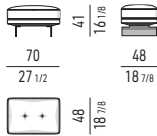

POUF CM **79X48**
OTTOMAN CM **79X48**

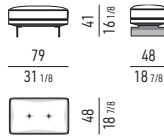

POUF CM **102X48**
OTTOMAN CM **102X48**

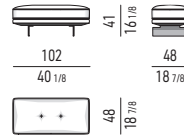

POUF CM **140X48**
OTTOMAN CM **140X48**

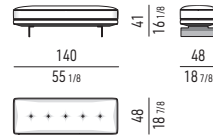

POUF CM **158X48**
OTTOMAN CM **158X48**

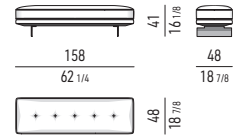

POUF CM **140X140**
OTTOMAN CM **140X140**

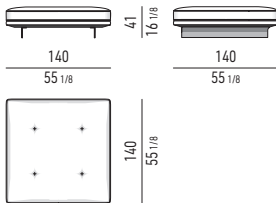

POUF INCLINATO | INCLINED OTTOMAN

POUF INCLINATO CM **109X98**
INCLINED OTTOMAN CM **109X98**

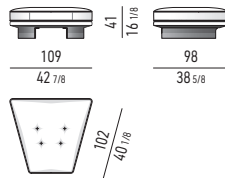

CUSCINI OPTIONAL | OPTIONAL CUSHIONS

CUSCINO SCHIENALE OPTIONAL CM **64X62**
OPTIONAL BACKREST CUSHION CM **64X62**

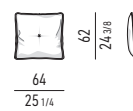

CUSCINO OPTIONAL CM **50X50**
OPTIONAL CUSHION CM **50X50**

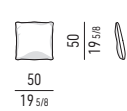

POGGIATESTA OPTIONAL | OPTIONAL HEADREST

POGGIATESTA OPTIONAL CM **64 H66**
OPTIONAL HEADREST CM **64 H66**

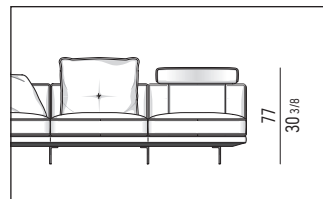
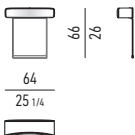

ABBINATO AD ELEMENTO CON MODULO SEDUTA CM **77**
PAIRED WITH ELEMENT WITH SEAT CUSHION CM **77**

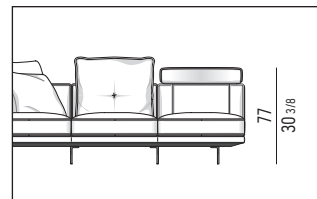

ABBINATO AD ELEMENTO CON MODULO SEDUTA CM **68**
PAIRED WITH ELEMENT WITH SEAT CUSHION CM **68**

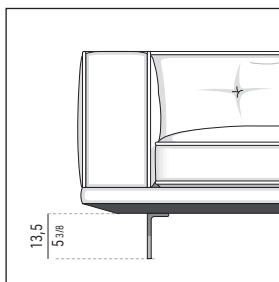

ALTEZZA DELLE **BASI**
HEIGHT OF THE **BASES**

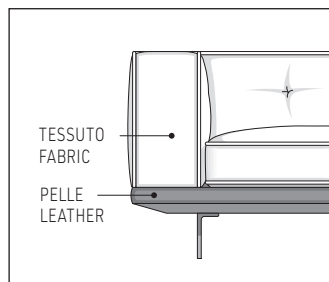

VERSIONE MIX - BASE **PELLE** / CUSCINI **TESSUTO**
MIX VERSION - **LEATHER** BASE / **FABRIC** CUSHIONS